



Rocky Mountain Snow Guards Inc

ROCKY MOUNTAIN SNOW GUARDS
4231 S NATCHES CT, UNIT C
ENGLEWOOD, CO 80110
PHONE: (877) 414-7606
FAX: (720) 387-8361
www.rockymountainsnowguards.com

SINGLE PLY II OR III SNOW FENCE SYSTEM

AVAILABLE MATERIALS:

- GALVANNEAL OR STAINLESS STEEL BASEPLATE
- ALUMINUM UPRIGHT
- ALUMINUM TUBING, CAPS, COLLARS AND FERRULES

OPTIONAL COMPONENTS:

- ICE FLAGS: ALUMINUM
- ICE SCREEN: ALUMINUM

All Aluminum, Stainless and Galvanneal parts are available powder coated or mill finish.

INFORMATION:

- Separate baseplate and upright design provides easy leak-proof installation with target patch flashing.
- Excellent load ratings when installed with CTX fasteners into solid blocking, steel or wood decking

Excellent choice for:

- New and existing EPDM, TPO or PVC roofs.
- Single Ply roofs installed over rigid insulation panels.

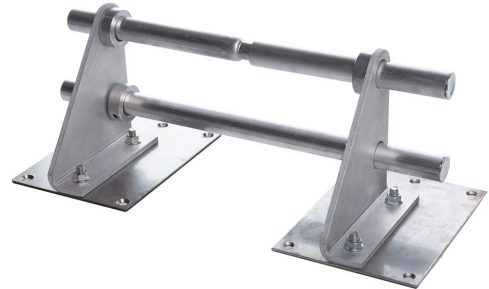

EXAMPLES:





Rocky Mountain Snow Guards Inc

ROCKY MOUNTAIN SNOW GUARDS
4231 S. NATCHES COURT, UNIT C
ENGLEWOOD, CO 80110
PHONE: (877) 414-7606
FAX: (720) 387-8361
www.rockymountainsnowguards.com

SELECT DESIRED MATERIAL:

ALUMINUM UPRIGHT
with BASEPLATE

SINGLE PLY FLASHING (NOT SUPPLIED BY
ROCKY MOUNTAIN SNOWGUARDS)
(RECOMMENDED SIZE 12" X 14")

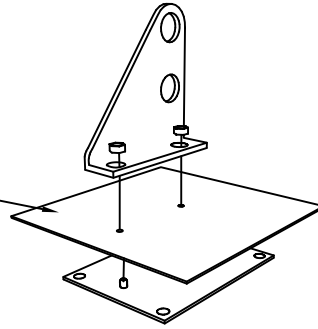

ISOMETRIC VIEW

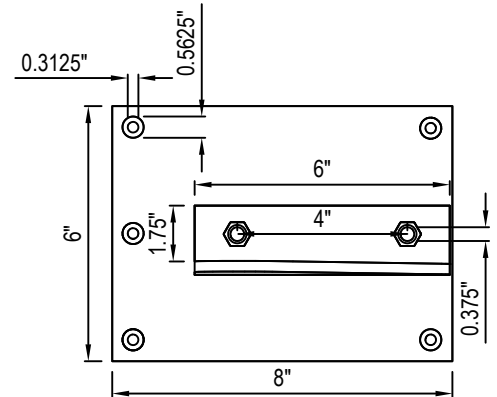

TOP VIEW

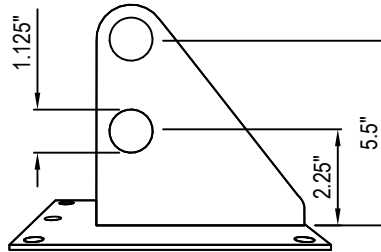

SIDE PERSPECTIVE

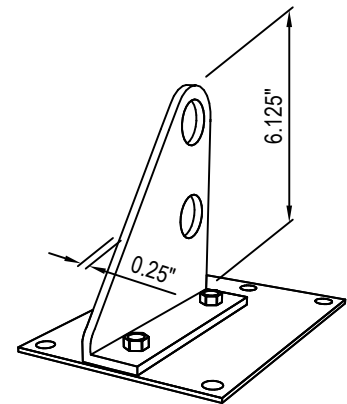

PERSPECTIVE

MANUFACTURER NOTES:

1. CONTACT MANUFACTURER FOR SELECTED LAYOUT.
2. FOR CUSTOM MATERIALS CONTACT MANUFACTURER.
3. OTHER SIZES ARE AVAILABLE ON A CUSTOM BASIS.

NOTES:

1. INSTALLATION TO BE COMPLETED IN ACCORDANCE WITH MANUFACTURER'S SPECIFICATIONS.
2. DO NOT SCALE DRAWING.
3. THIS DRAWING IS INTENDED FOR USE BY ARCHITECTS, ENGINEERS, CONTRACTORS, CONSULTANTS AND DESIGN PROFESSIONALS FOR PLANNING PURPOSES ONLY. THIS DRAWING MAY NOT BE USED FOR CONSTRUCTION.
4. ALL INFORMATION CONTAINED HEREIN WAS CURRENT AT THE TIME OF DEVELOPMENT BUT MUST BE REVIEWED AND APPROVED BY THE PRODUCT MANUFACTURER TO BE CONSIDERED ACCURATE.
5. CONTRACTOR'S NOTE: FOR PRODUCT AND COMPANY INFORMATION VISIT www.CADdetails.com/info AND ENTER REFERENCE NUMBER 5281-004

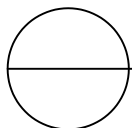

SNOW FENCE BRACKETS

SINGLE PLY 2-PIPE SNOW FENCE BRACKET



Rocky Mountain Snow Guards Inc

ROCKY MOUNTAIN SNOW GUARDS
4231 S NATCHES COURT, UNIT C
ENGLEWOOD, CO 80110
PHONE: (877) 414-7606
FAX: (720) 387-8361
www.rockymountainsnowguards.com

ALUMINUM SNOW FENCE COMPONENTS

SELECT DESIRED MATERIAL:

- ALUMINUM
- POWDER COATED ALUMINUM

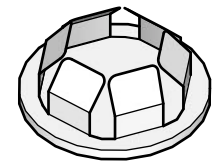
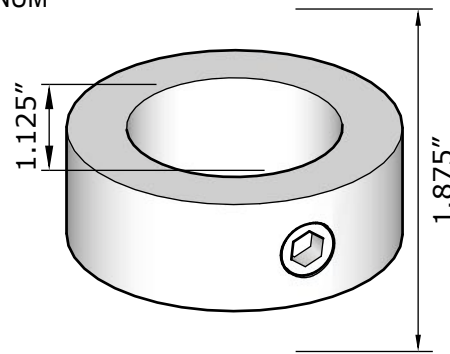
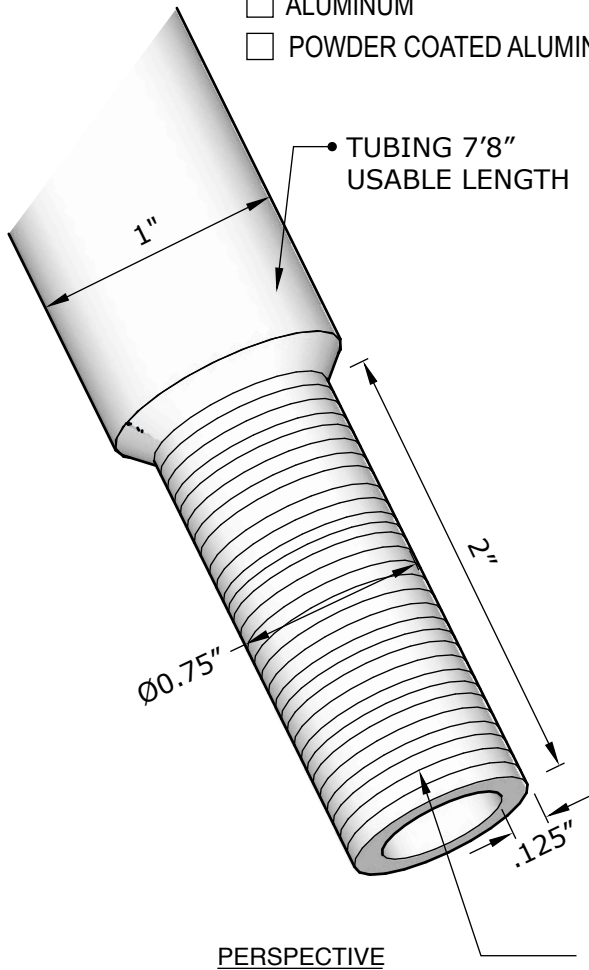

TOP PERSPECTIVE
END CAP

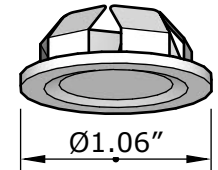
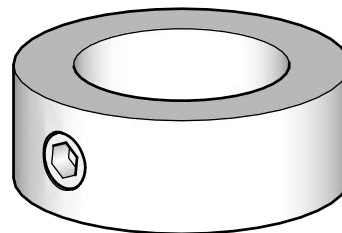

SHOWN WITH SWAGED END TO
CONNECT TO TUBES - OVERALL LENGTH 7'10"
ALTERNATE: 7'8" TUBING WITH SEPARATE INTERNAL COUPLER

MANUFACTURER NOTES:

1. CONTACT MANUFACTURER FOR SPECIFIED LAYOUT PATTERN.
2. FOR CUSTOM MATERIALS CONTACT MANUFACTURER.
3. OTHER SIZES ARE AVAILABLE ON A CUSTOM BASIS.

NOTES:

1. INSTALLATION TO BE COMPLETED IN ACCORDANCE WITH MANUFACTURER'S SPECIFICATIONS.
2. DO NOT SCALE DRAWING.



Rocky Mountain Snow Guards Inc

Installation Instructions for Single Ply 2-Pipe Snow Fence Bracket

The Single Ply 2-Pipe snow fence bracket system is comprised of 3 parts.

1. 2-Pipe Aluminum Upright
2. Target Flashing
3. Stainless Steel or Galvanneal Baseplate

Installation of the Baseplate:

1. The baseplate is placed on top of the finished roof system and located as indicated on the snow retention plan provided by Rocky Mountain Snow Guards. Generally, the snow fence system will be 12" from the eave edge. The baseplate is positioned with 3 attachment holes at the top.
2. The baseplates are fastened into place with 5 fasteners of the type recommended for the specific job conditions. The Single Ply bracket is usually fastened into solid wood blocking on insulated roofing systems although fastening through wood decking is also acceptable provided there is no insulation between the decking and the membrane.

Installation of the Target Flashing:

1. The target flashing must be of the same material as the roofing system.
2. Each target flashing should be a minimum of 12" x 14".
3. Holes are cut through the target flashing to correspond with the upright studs on the baseplate.
4. Apply sealant around each upright stud and push flashing into place over the studs.
5. Heat seam, tape or glue the target flashing to the roof membrane as required by the membrane manufacturer.

Installation of the 2-Pipe Aluminum Upright:

1. Slide the upright over the upright studs.
2. Tighten the supplied Stainless Steel nuts.











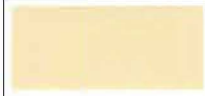
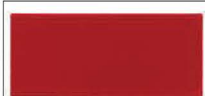





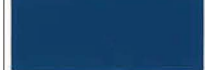











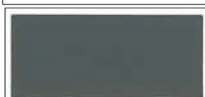









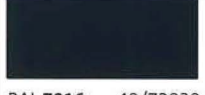



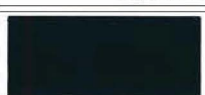





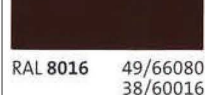

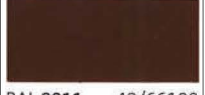



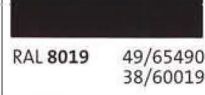

Notes:

1. Rocky Mountain Snow Guards can provide job specific snow retention plans with bracket spacing, recommended fasteners and snow fence locations.
2. Powder coating is available at an additional charge.

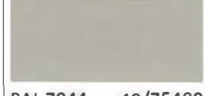

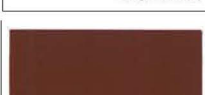
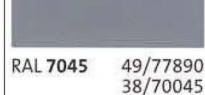
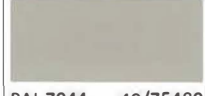
Rocky Mountain Snow Guards Inc

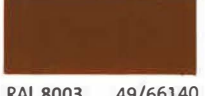
These are the colors available for
snow guards and snow fences.
RockyMountainSnowGuard.com
Ph: 877-414-7606

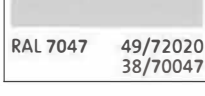
 RAL 1000 49/15200 38/15000	 RAL 1015 49/15320 38/15015	 RAL 3000 49/33120 38/30000	 RAL 6016 49/51020 38/50016	 RAL 6029 49/52640 38/50029	 RAL 7006 49/72580 38/70006
 RAL 1001 49/15190 38/15001	 RAL 1016 49/22520 38/20016	 RAL 3001 49/31120 38/30001	 RAL 5009 49/42270 38/40009	 RAL 6033 49/55010 38/50033	 RAL 7010 49/72560 38/70014
 RAL 1019 49/13660 38/15019	 RAL 3007 49/31910 38/30007	 RAL 3031 49/34730 38/30031	 RAL 6009 49/52840 38/50009	 RAL 7004 49/73300 38/70004	 RAL 7011 49/72790 38/70011
 RAL 5017 49/40760 38/40017	 RAL 3009 49/31920 38/30009	 RAL 5003 49/42230 38/40003	 RAL 5024 49/44660 38/40024	 RAL 7005 49/72590 38/70005	 RAL 7012 49/71180 38/70012
 RAL 5018 49/41140 38/40020	 RAL 3011 49/31090 38/30011	 RAL 5001 49/42210 38/40001	 RAL 6000 49/53160 38/50000	 RAL 6021 49/52700 38/50021	 RAL 7015 49/72820 38/70015
 RAL 7023 49/72530 38/70023	 RAL 6005 49/50670 38/50002	 RAL 3013 49/31950 38/30013	 RAL 6002 49/52890 38/50023	 RAL 6011 49/52820 38/50011	 RAL 7016 49/72830 38/70016
 RAL 7022 49/72850 38/70022	 RAL 5015 49/42330 38/40015	 RAL 6015 49/52790 38/50015	 RAL 5014 49/42320 38/40014	 RAL 6012 49/51540 38/50012	 RAL 7021 49/72540 38/70021
 RAL 7032 49/72910 38/70001	 RAL 8007 49/66120 38/60007	 RAL 8025 49/66050 38/60025	 RAL 9004 49/81950 38/80004	 RAL 8016 49/66080 38/60016	
 RAL 7033 49/72510 38/70033	 RAL 7040 49/75470 38/70046	 RAL 8028 49/66500 38/60028	 RAL 7039 49/71020 38/70039	 RAL 8017 49/65220 38/60017	
 RAL 7035 49/73510 38/70035	 RAL 7042 49/73250 38/70042	 RAL 8012 49/66090 38/60012	 RAL 9002 49/70520 38/10002	 RAL 8024 49/66060 38/60024	 RAL 8019 49/65490 38/60019
 RAL 7036 49/72950 38/70036	 RAL 7043 49/72460 38/70043	 RAL 8014 49/65230 38/60010	 RAL 9003 49/11400 38/10003	 RAL 8002 49/66150 38/60002	 RAL 7045 49/77890 38/70045
 RAL 7044 49/75480 38/70044	 RAL 8004 49/66130 38/60004	 RAL 8003 49/66140 38/60003	 RAL 7037 49/72480 38/70037	 RAL 7047 49/72020 38/70047	



POWDER COATING COLOR SIGN-OFF FORM

RMSG STANDARD COLORS

Black



Harbor Gray



Liberty Gray



Medium Bronze



Dark Bronze*



Standard Color Name or Custom Powder Color Code: _____

To remove the powder coating option, enter "MILL FINISH" in the Color Code line above.

***Dark Bronze snow fence systems will include anodized tubing.**

Colors vary from manufacturers and colors selected from a digital source may not resemble the final product. By signing this document we herein authorize Rocky Mountain Snow Guards Inc. to use the selected color choice to powder coat the purchased product. Furthermore, I recognize that powder coatings may not match the roof color exactly but are meant to be similar or complimentary to the existing roof color. Color samples are available upon request.



Rocky Mountain Snow Guards Inc

ROCKY MOUNTAIN SNOW GUARDS
4231 S. NATCHES COURT, UNIT C
ENGLEWOOD, CO 80110
PHONE: (877) 414-7606
FAX: (720) 387-8361
www.rockymountainsnowguards.com

Rocky Mountain Snow Guards Snow Retention System Maintenance Guide

Systems designed by Rocky Mountain Snow Guards, installed properly should last the life of the roof. Rocky Mountain does not recommend adhesive tape or sealant attachment for any snow fence or snow guard system. Rocky Mountain snow retention systems installed on commercial buildings, above high traffic areas or in areas with high snow loads should be inspected by a qualified roofing or snow retention professional on an annual basis to ensure the system will continue to perform as designed.

Bolt Down Snow Fence Systems:

1. Inspect brackets, snow fence components and fasteners for evidence of damage.
2. Replace damaged parts prior to the next snow season.

Clamp to Seam Snow Fence and Snow Bar Systems:

1. Inspect brackets, snow fence and snow bar components for evidence of damage.
2. Replace damaged parts prior to the next snow season.
3. Check torque on set screws with an appropriate torque wrench.
4. Torque set screws to recommended torque. This is especially important after the 1st snow season.

Snow Guards:

1. Inspect snow guards for evidence of damage.
2. Inspect exposed fasteners.
3. Replace damaged parts prior to the next snow season.