



# Rocky Mountain Snow Guards Inc

ROCKY MOUNTAIN SNOW GUARDS  
4231 S NATCHES CT, UNIT C  
ENGLEWOOD, CO 80110  
PHONE: (877) 414-7606  
FAX: (720) 387-8361  
[www.rockymountainsnowguards.com](http://www.rockymountainsnowguards.com)

## BLIZZARD Heavy Duty III SNOW FENCE SYSTEM

### AVAILABLE MATERIALS:

- S-5! Aluminum Standard Clamps with Stainless Steel Hardware
- Aluminum Upright
- Aluminum Tubing, End Collars and End Caps

### OPTIONAL COMPONENTS:

- Aluminum Ice Flags
- Aluminum Ice Screen

All Aluminum and Stainless parts are available powder coated or mill finish.

### INFORMATION:

- Blizzard Heavy Duty II brackets feature S-5! Clamps for all types of standing seam profiles
- Brackets and clamps are pre-assembled for quick onsite attachment.

Excellent choice for:

- New and Existing Standing Seam Roofs



*S-5-S Clamp Shown*



### EXAMPLES:





# Rocky Mountain Snow Guards Inc

ROCKY MOUNTAIN SNOW GUARDS  
4231 S NATCHES COURT, UNIT C  
ENGLEWOOD, CO 80110  
PHONE: (877) 414-7606  
FAX: (720) 387-8361  
www.rockymountainsnowguards.com

## BLIZZARD HEAVY DUTY III SNOW FENCE SYSTEM

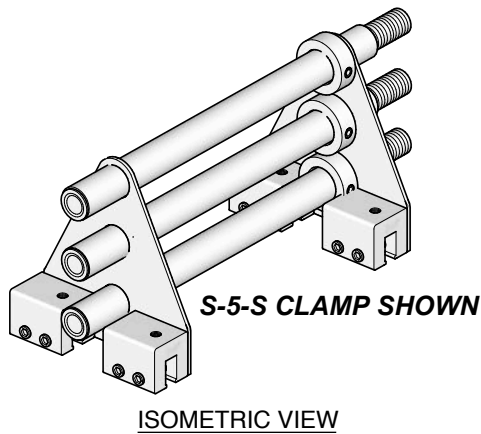
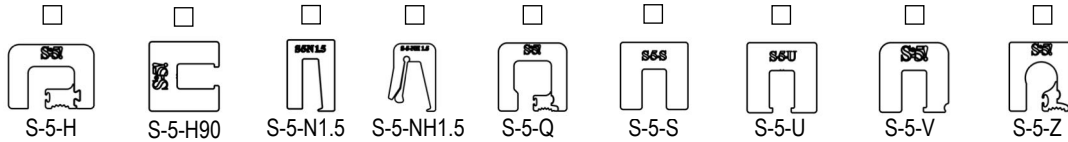

**S-5-S CLAMP SHOWN**

ISOMETRIC VIEW

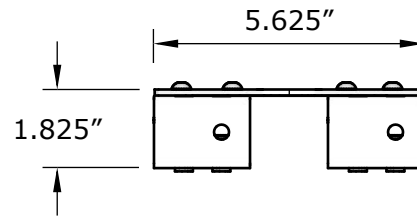

TOP VIEW

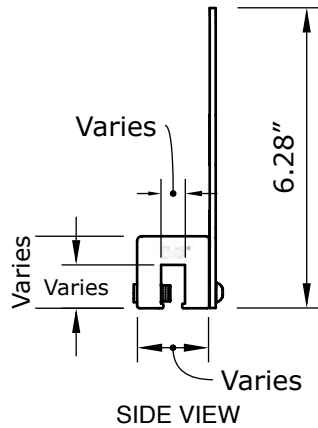

SIDE VIEW

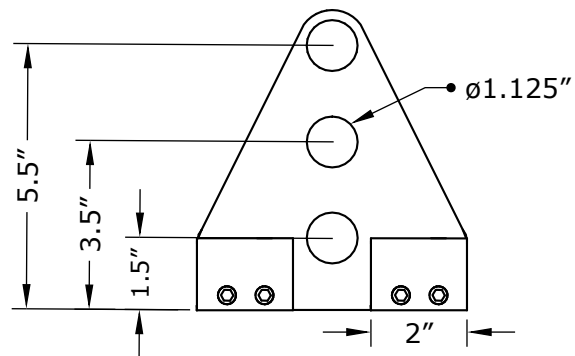

FRONT VIEW

### MANUFACTURER NOTES:

1. CONTACT MANUFACTURER FOR SPECIFIED LAYOUT PATTERN.
2. FOR CUSTOM MATERIALS CONTACT MANUFACTURER.
3. OTHER SIZES ARE AVAILABLE ON A CUSTOM BASIS.

### NOTES:

1. INSTALLATION TO BE COMPLETED IN ACCORDANCE WITH MANUFACTURER'S SPECIFICATIONS.
2. DO NOT SCALE DRAWING.

The strength of the S-5-V clamp is in its simple design. The patented setscrews will slightly dimple the metal seam material but not pierce it—leaving the roof manufacturer's warranty intact.

The **S-5-V** and **S-5-V Mini** clamps are each furnished with the hardware shown to the right. Each box also includes a bit tip for tightening setscrews using an electric screw gun. A structural aluminum attachment clamp, the S-5-V is compatible with most common metal roofing materials excluding copper. All included hardware is stainless steel. Please visit [www.S-5.com](http://www.S-5.com) for more information including CAD details, metallurgical compatibilities, and specifications.

The S-5-V clamp has been tested for load-to-failure results on most major brands and profiles of standing seam roofing. The independent lab test data found at [www.S-5.com](http://www.S-5.com) can be used for load-critical designs and applications. S-5!<sup>®</sup> holding strength is unmatched in the industry.

## Example Profiles

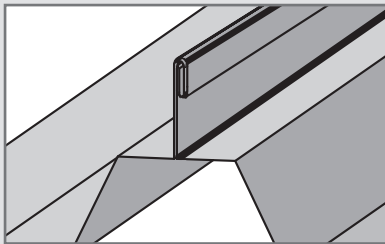
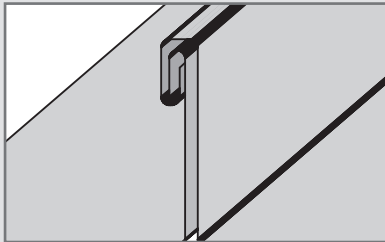

## S-5-V Clamp

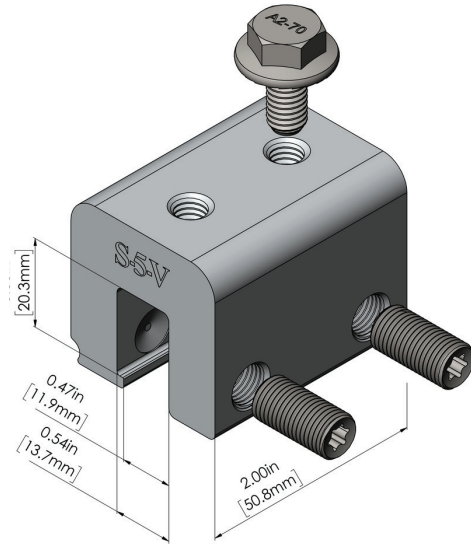

## S-5-V Mini Clamp

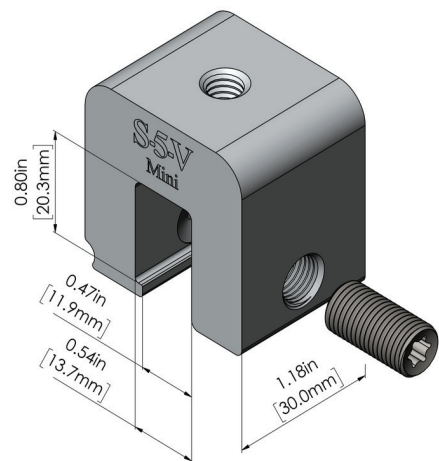

### S-5!<sup>®</sup> Warning! Please use this product responsibly!

Products are protected by multiple U.S. and foreign patents. Visit the website at [www.S-5.com](http://www.S-5.com) for complete information on patents and trademarks. Consult the S-5! website at [www.S-5.com](http://www.S-5.com) for published data regarding installation instructions and holding strength.

Copyright 2021, Metal Roof Innovations, Ltd. S-5! products are patent protected. S-5! aggressively protects its patents, trademarks, and copyrights. Version 081721.

Distributed by



## Rocky Mountain Snow Guards Inc

4231 S. Natches Court, Unit C, Englewood, CO 80110  
(877) 414-7606 / [www.rockymountainsnowguards.com](http://www.rockymountainsnowguards.com)



# Rocky Mountain Snow Guards Inc

ROCKY MOUNTAIN SNOW GUARDS  
4231 S NATCHES COURT, UNIT C  
ENGLEWOOD, CO 80110  
PHONE: (877) 414-7606  
FAX: (720) 387-8361  
www.rockymountainsnowguards.com

## ALUMINUM SNOW FENCE COMPONENTS

SELECT DESIRED MATERIAL:

- ALUMINUM
- POWDER COATED ALUMINUM

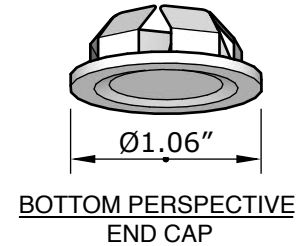
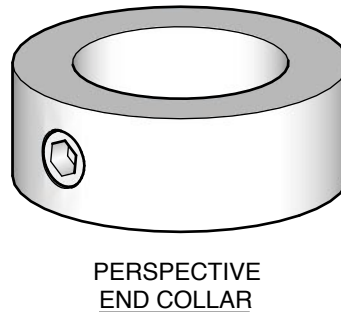
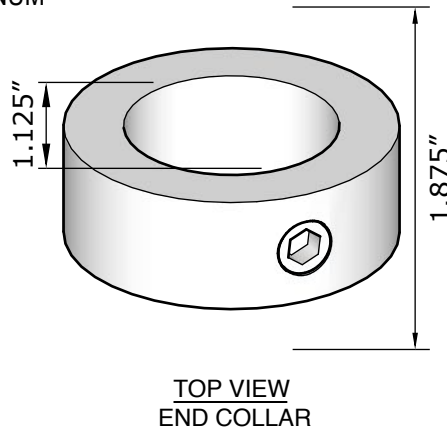
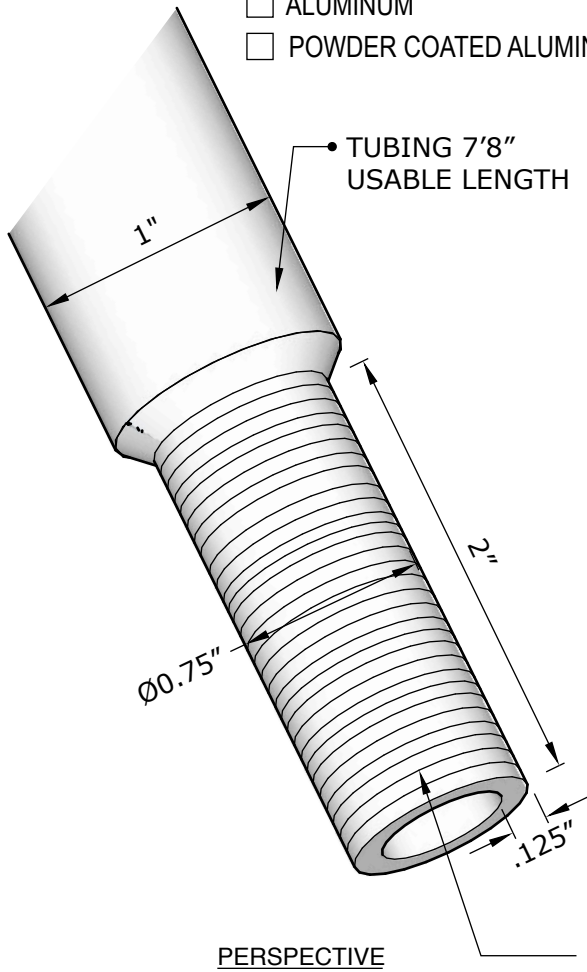

SHOWN WITH SWAGED END TO  
CONNECT TO TUBES - OVERALL LENGTH 7'10"  
ALTERNATE: 7'8" TUBING WITH SEPARATE INTERNAL COUPLER

### MANUFACTURER NOTES:

1. CONTACT MANUFACTURER FOR SPECIFIED LAYOUT PATTERN.
2. FOR CUSTOM MATERIALS CONTACT MANUFACTURER.
3. OTHER SIZES ARE AVAILABLE ON A CUSTOM BASIS.

### NOTES:

1. INSTALLATION TO BE COMPLETED IN ACCORDANCE WITH MANUFACTURER'S SPECIFICATIONS.
2. DO NOT SCALE DRAWING.



# Rocky Mountain Snow Guards Inc

ROCKY MOUNTAIN SNOW GUARDS  
4231 S NATCHES COURT, UNIT C  
ENGLEWOOD, CO 80110  
PHONE: (877) 414-7606  
FAX: (720) 387-8361  
[www.rockymountainsnowguards.com](http://www.rockymountainsnowguards.com)

## ICE FLAG - SNOW FENCE SYSTEM ACCESSORY

SELECT DESIRED MATERIAL:

- COPPER - 16 OZ
- PAINTED ALUMINUM - 0.032"

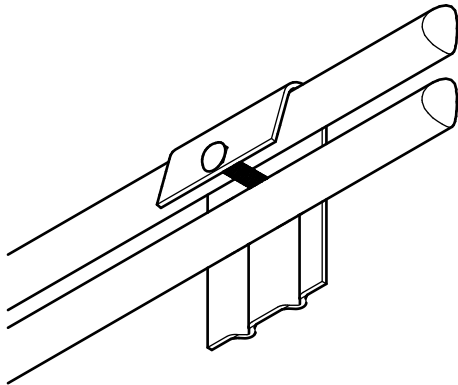

ISOMETRIC VIEW

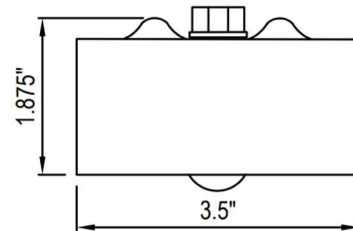

TOP VIEW

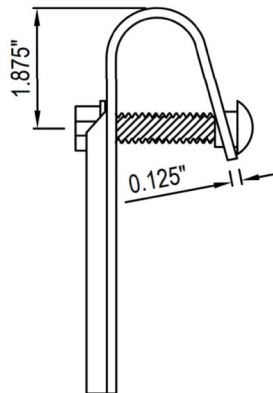

SIDE VIEW

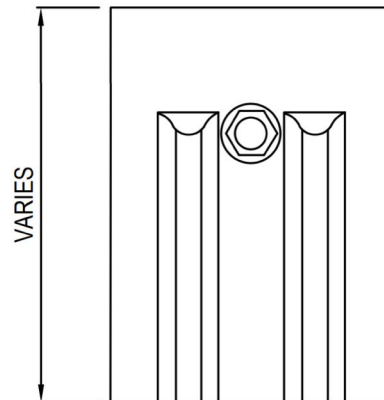

FRONT VIEW

### MANUFACTURER NOTES:

1. CONTACT MANUFACTURER FOR SPECIFIED LAYOUT PATTERN.
2. FOR CUSTOM MATERIALS CONTACT MANUFACTURER.
3. OTHER SIZES ARE AVAILABLE ON A CUSTOM BASIS.

### NOTES:

1. INSTALLATION TO BE COMPLETED IN ACCORDANCE WITH MANUFACTURER'S SPECIFICATIONS.
2. DO NOT SCALE DRAWING.





# Rocky Mountain Snow Guards Inc

ROCKY MOUNTAIN SNOW GUARDS  
4231 S NATCHES COURT, UNIT C  
ENGLEWOOD, CO 80110  
PHONE: (877) 414-7606  
FAX: (720) 387-8361  
[www.rockymountainsnowguards.com](http://www.rockymountainsnowguards.com)

## ICE SCREEN - SNOW FENCE SYSTEM ACCESSORY

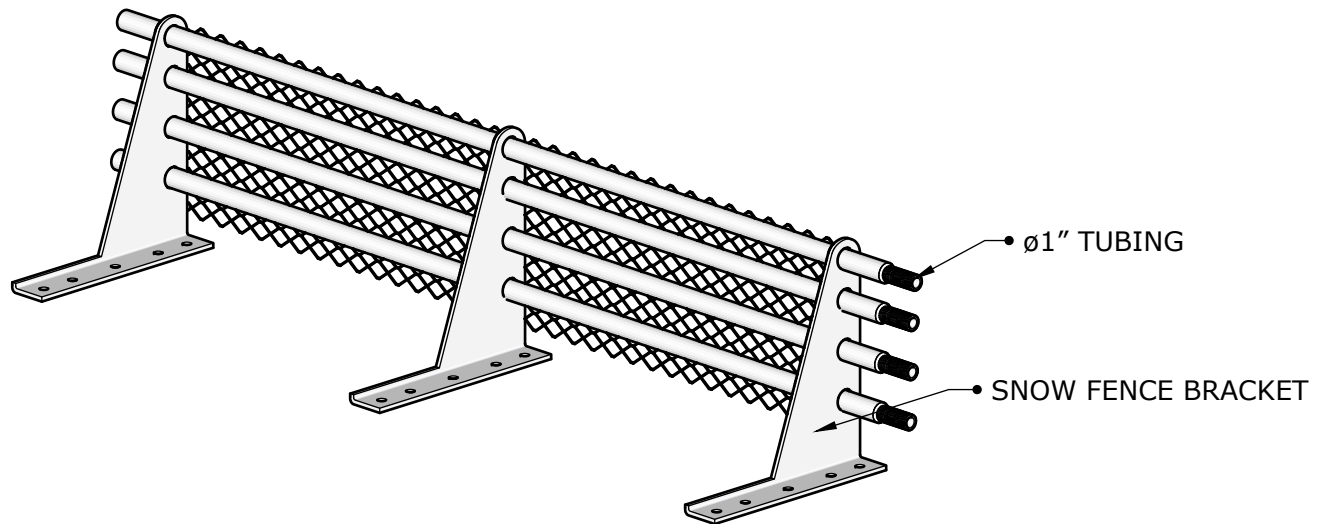

ISOMETRIC VIEW

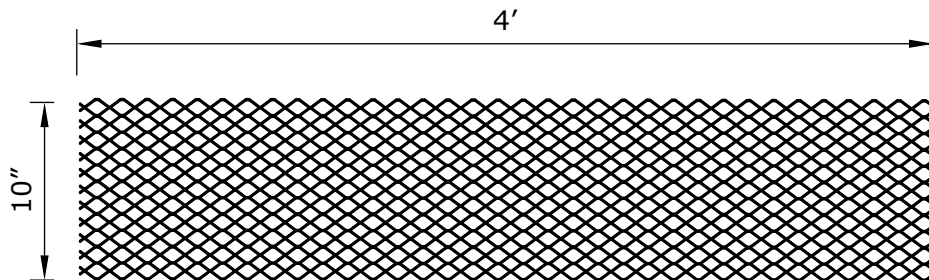

FRONT VIEW

### MANUFACTURER NOTES:

1. CONTACT MANUFACTURER FOR SPECIFIED LAYOUT PATTERN.
2. FOR CUSTOM MATERIALS CONTACT MANUFACTURER.
3. OTHER SIZES ARE AVAILABLE ON A CUSTOM BASIS.
4. MANUFACTURED OF EXPANDED T6061 ALUMINUM.











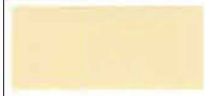
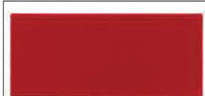





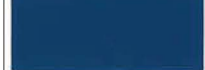











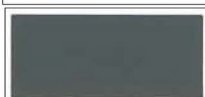

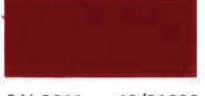







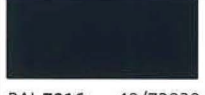



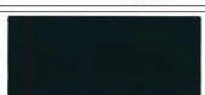





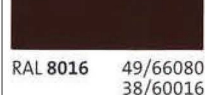





### NOTES:

1. INSTALLATION TO BE COMPLETED IN ACCORDANCE WITH MANUFACTURER'S SPECIFICATIONS.
2. DO NOT SCALE DRAWING.

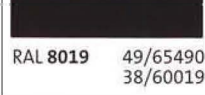

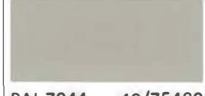
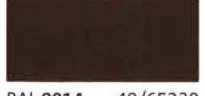
# Rocky Mountain Snow Guards Inc

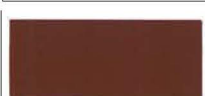
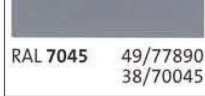
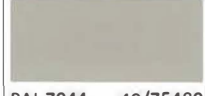
These are the colors available for  
snow guards and snow fences.  
RockyMountainSnowGuard.com  
Ph: 877-414-7606

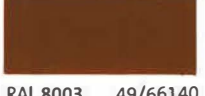
 RAL 1000 49/15200 38/15000	 RAL 1015 49/15320 38/15015	 RAL 3000 49/33120 38/30000	 RAL 6016 49/51020 38/50016	 RAL 6029 49/52640 38/50029	 RAL 7006 49/72580 38/70006
 RAL 1001 49/15190 38/15001	 RAL 1016 49/22520 38/20016	 RAL 3001 49/31120 38/30001	 RAL 5009 49/42270 38/40009	 RAL 6033 49/55010 38/50033	 RAL 7010 49/72560 38/70014
 RAL 1019 49/13660 38/15019	 RAL 3007 49/31910 38/30007	 RAL 3031 49/34730 38/30031	 RAL 6009 49/52840 38/50009	 RAL 7004 49/73300 38/70004	 RAL 7011 49/72790 38/70011
 RAL 5017 49/40760 38/40017	 RAL 3009 49/31920 38/30009	 RAL 5003 49/42230 38/40003	 RAL 5024 49/44660 38/40024	 RAL 7005 49/72590 38/70005	 RAL 7012 49/71180 38/70012
 RAL 5018 49/41140 38/40020	 RAL 3011 49/31090 38/30011	 RAL 5001 49/42210 38/40001	 RAL 6000 49/53160 38/50000	 RAL 6021 49/52700 38/50021	 RAL 7015 49/72820 38/70015
 RAL 7023 49/72530 38/70023	 RAL 6005 49/50670 38/50002	 RAL 3013 49/31950 38/30013	 RAL 6002 49/52890 38/50023	 RAL 6011 49/52820 38/50011	 RAL 7016 49/72830 38/70016
 RAL 7022 49/72850 38/70022	 RAL 5015 49/42330 38/40015	 RAL 6015 49/52790 38/50015	 RAL 5014 49/42320 38/40014	 RAL 6012 49/51540 38/50012	 RAL 7021 49/72540 38/70021
 RAL 7032 49/72910 38/70001	 RAL 8007 49/66120 38/60007	 RAL 8025 49/66050 38/60025	 RAL 9004 49/81950 38/80004	 RAL 8016 49/66080 38/60016	
 RAL 7033 49/72510 38/70033	 RAL 7040 49/75470 38/70046	 RAL 8028 49/66500 38/60028	 RAL 7039 49/71020 38/70039	 RAL 8017 49/65220 38/60017	
 RAL 7035 49/73510 38/70035	 RAL 7042 49/73250 38/70042	 RAL 8012 49/66090 38/60012	 RAL 9002 49/70520 38/10002	 RAL 8024 49/66060 38/60024	 RAL 8019 49/65490 38/60019
 RAL 7036 49/72950 38/70036	 RAL 7043 49/72460 38/70043	 RAL 8014 49/65230 38/60010	 RAL 9003 49/11400 38/10003	 RAL 8002 49/66150 38/60002	 RAL 7045 49/77890 38/70045
 RAL 7044 49/75480 38/70044	 RAL 8004 49/66130 38/60004	 RAL 8003 49/66140 38/60003	 RAL 7037 49/72480 38/70037	 RAL 7047 49/72020 38/70047	



---

## POWDER COATING COLOR SIGN-OFF FORM

### RMSG STANDARD COLORS

Black



Harbor Gray



Liberty Gray



Medium Bronze



Dark Bronze\*



**Standard Color Name or Custom Powder Color Code:** \_\_\_\_\_

To remove the powder coating option, enter "MILL FINISH" in the Color Code line above.

**\*Dark Bronze snow fence systems will include anodized tubing.**

Colors vary from manufacturers and colors selected from a digital source may not resemble the final product. By signing this document we herein authorize Rocky Mountain Snow Guards Inc. to use the selected color choice to powder coat the purchased product. Furthermore, I recognize that powder coatings may not match the roof color exactly but are meant to be similar or complimentary to the existing roof color. Color samples are available upon request.





# Rocky Mountain Snow Guards Inc

ROCKY MOUNTAIN SNOW GUARDS  
4231 S. NATCHES COURT, UNIT C  
ENGLEWOOD, CO 80110  
PHONE: (877) 414-7606  
FAX: (720) 387-8361  
[www.rockymountainsnowguards.com](http://www.rockymountainsnowguards.com)

## Blizzard II, Blizzard Heavy Duty II and III Clamp-to-Seam Snow Fence Installation Instructions

Each Blizzard II is comprised of (2) S-5! Mini Clamps pre-attached to a 2-pipe aluminum upright.  
Blizzard Heavy Duty II and III are comprised of 2 S-5! Standard Clamps attached to aluminum upright.

1. Screw stainless steel setscrew(s) into each clamp.

~2 Set Screws on each Blizzard II Bracket

~4 Set Screws on each Blizzard Heavy Duty II and III  
Bracket



2. Using a laser level or chalk line, mark locations for brackets 12" from eave edge.

1st course only, more snow fence rows may be necessary. Consult Rocky Mountain Snow Guards Snow Retention Plan for location of additional rows.

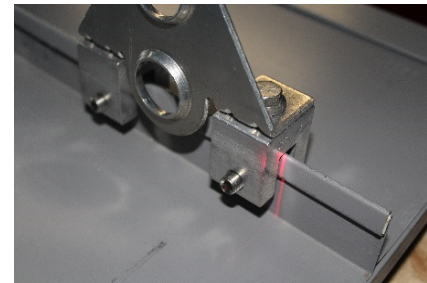

3. Tighten each set screw. Torque wrenches are a must to achieve the torque.

Torque wrenches are a must to achieve the torque recommended for your specific panel. Recommended torque can be found at [www.s-5.com](http://www.s-5.com).

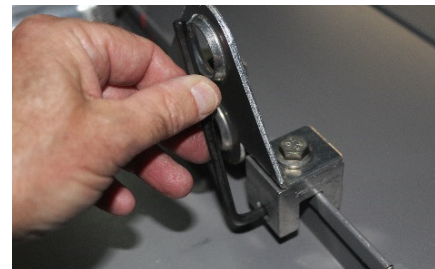



# Rocky Mountain Snow Guards Inc

## Blizzard II, Blizzard Heavy Duty II and III Clamp-to-Seam Snow Fence Installation Instructions Con't)

4. Insert 1" O/D Aluminum Tubing through brackets.



5. Slide Swaged Tube end into unfinished end of adjacent tubes to complete run.

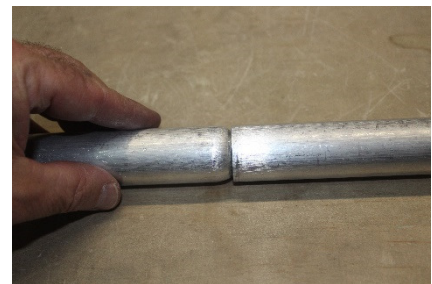
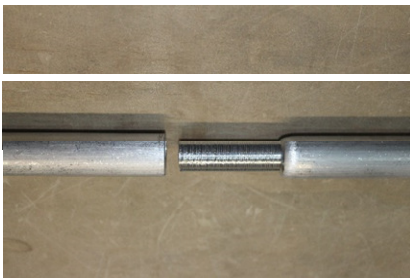

6. Slide End Collars onto tubing and tighten, being careful to locate the collars on the INSIDE of the last bracket in a run.

Collars must be installed to the inside of the last bracket to hold tubing together at joints.



7. Insert End Caps and attach Ice Flags (if needed).



## Installation Instructions

**S-5!® Warning!** Please use these products responsibly! Visit our website or contact your S-5! distributor for available load test results. The user and/or installer of these parts is responsible for all necessary engineering and design to ensure the S-5! clamps have been properly spaced and configured. **Notice to S-5! users:** Due to the many variables involved with specific panel products, climates, snow melt phenomena, and job particulars, the manufacturer cannot and does not express any opinions as to the suitability of any S-5! assembly for any specific application and assumes no liability with respect thereto. S-5! products are tested for ultimate holding strength on various profile types and materials. Visit [www.S-5.com](http://www.S-5.com) for more details. This document is an installation guide only and the photographs and drawings herein are for the purpose of illustrating installation, tools and techniques, not system designs. Information contained within is intended to apply to the document as a whole.

**The S-5-U, S-5-S, S-5-E, S-5-B, and S-5-V clamps are made for standing seam profiles.** For horizontal seam applications, the setscrew(s) must be accessible from the top for tightening. S-5-U clamps have two bolt holes to accommodate either vertical or horizontal seam applications; visit [www.S-5.com](http://www.S-5.com) for more details.

## Tools Needed

- Screw Gun\*
- T30 Torx Bit Tip (provided)
- Dial-Calibrated Torque Wrench  
(For accurate tension values, do NOT use a clicking torque wrench; inquire with S-5! for proper tool sourcing)

## To Install the S-5-U, S-5-S, S-5-E, S-5-B, and S-5-V

1. Partially thread the setscrews into the clamp by hand. (The S-5-U has four setscrew locations to make the clamp more versatile; however, only two setscrews are used per clamp. Both setscrews should always be loaded into the same side of the clamp.)
2. Determine how to position the clamp. When attaching to machine-folded seams (regardless of panel profile and geometry), S-5! clamps are designed to engage the seam as shown in Illustration A; with setscrew opposite seam fold. On many snap-together type seams, the setscrews are on the open (or overlap) side of the seam. On some seams, this aspect of clamp orientation is not critical.
3. Tighten the setscrews using a screw gun\* and the included screw gun bit tip. Setscrews should be tensioned and re-tensioned as the seam material compresses, i.e. tighten the first setscrew, then the second; then repeat until each setscrew achieves the recommended torque. The setscrews will dimple the seam material but will not penetrate it. When relying on published load values, setscrew tension should be verified periodically using a calibrated torque wrench as indicated below to ensure the tool is consistently achieving the proper torque range. **Note:** See "Step 3 Note" at bottom of document on fitting S-5-U and S-5-V on certain vertical double-folds.

\* For time-saving tool recommendations, call S-5!

Specified Torque	Inch Pounds	Foot Pounds	Nm
22ga steel	160–180	13–15	18–20
All other metals and thinner gauges of steel	130–150	11–12.5	15–17

Once installed correctly, these clamps require no maintenance or re-inspection for the life of the roof.

4. For critical attachment applications utilizing an M8-1.25 X 16 mm Hex Flange Bolt, tighten the included M8 bolt to 160 inch pounds (13 foot pounds).

These instructions are for use by those experienced in the trade. Always follow appropriate safety precautions and use appropriate tools.

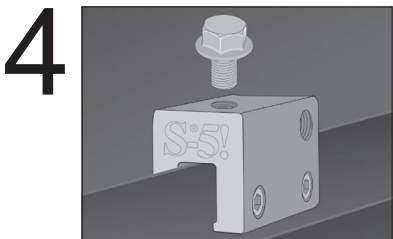
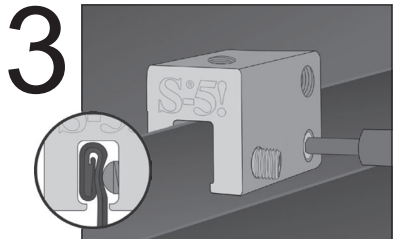
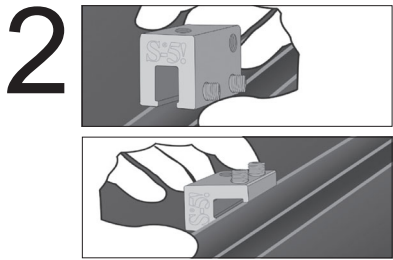
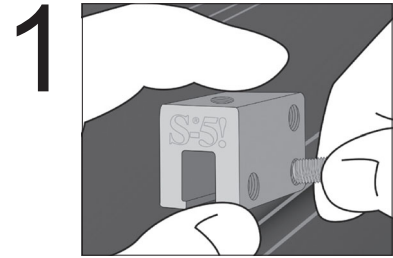

Above illustrations show S-5-U clamp on a vertical seam. Step 2 shows both vertical and horizontal applications.

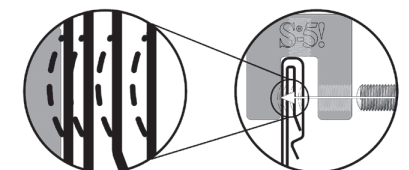
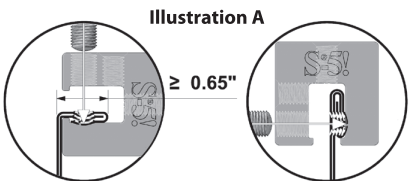

(Top) S-5-U clamp on both vertical and horizontal seams.

(Bottom) S-5-S on a snap together seam with blow up illustrating deformation of seam as setscrew is tightened

**For horizontal seams equal to or greater than .65" use the S-5-U in its horizontal orientation.**

**For horizontal seams equal to or less than .50" use the S-5-S mounted vertically.**

## S-5-U Mini, S-5-S Mini, S-5-E Mini, S-5-B Mini, and S-5-V Mini Installation Instructions

### To Install the S-5-U Mini, S-5-S Mini, S-5-E Mini, S-5-B Mini, and S-5-V Mini

1. Partially thread the setscrew into the clamp by hand.
2. Determine how to position the clamp. When attaching to machine-folded seams (regardless of panel profile and geometry), S-5!® clamps are designed to engage the seam as shown in Illustration A on the front page; with setscrew opposite seam fold. On many snap-together type seams, the setscrew is on the open (or overlap) side of the seam. On some seams, this aspect of clamp orientation is not critical.
3. Tighten the setscrew using a screw gun\* and the included screw gun bit tip. The setscrew will dimple the seam material but will not penetrate it. When relying on published load values, setscrew tension should be verified periodically using a calibrated torque wrench as indicated below to ensure the tool is consistently achieving the proper torque range. **Note:** See "Step 3 Note" at bottom of document on fitting S-5-U Mini and S-5-V Mini on certain vertical double-folds.

\*For time-saving tool recommendations, call S-5!

Specified Torque	Inch Pounds	Foot Pounds	Nm
22ga steel	160-180	13-15	18-20
All other metals and thinner gauges of steel	130-150	11-12.5	15-17

Once installed correctly, these clamps require no maintenance or re-inspection for the life of the roof.

4. For critical attachment applications utilizing an M8-1.25 X 16 mm Hex Flange Bolt (sold separately), tighten the bolt to 160 inch pounds (13 foot pounds).

**Step 3 Note:** When installing S-5-U, S-5-V, S-5-U Mini, or S-5-V Mini on a vertical double fold, you may need to lift clamp in a manner that allows the lip of the clamp to engage the bottom of the seam and the setscrew(s) to fully engage the fold while tightening the setscrew(s). See clamp lip engagement in figure below. This will assist in making the clamp sit more vertically on the seam.

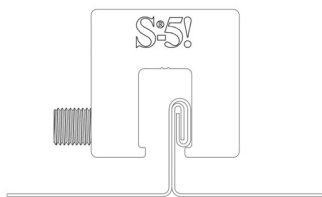

**NOTE:** Any S-5! warranty and/or calculation may be void if hardware is used that was not furnished by S-5! directly or through one of their licensed distributors

#### S-5!® Warning! Please use this product responsibly!

Products are protected by multiple U.S. and foreign patents. Visit the website at [www.S-5.com](http://www.S-5.com) for complete information on patents and trademarks. For maximum holding strength, setscrews should be tensioned and re-tensioned as the seam material compresses, i.e. tighten the first setscrew, then the second; then repeat until each setscrew achieves the recommended torque. Clamp setscrew tension should be verified using a calibrated torque wrench between 160 and 180 inch pounds when used on 22ga steel, and between 130 and 150 inch pounds for all other metals and thinner gauges of steel. Consult the S-5! website at [www.S-5.com](http://www.S-5.com) for published data regarding holding strength.

Copyright 2020, Metal Roof Innovations, Ltd. S-5! products are patent protected. S-5! aggressively protects its patents, trademarks, and copyrights. Version 040820.

USEBVI-V1.2-0420

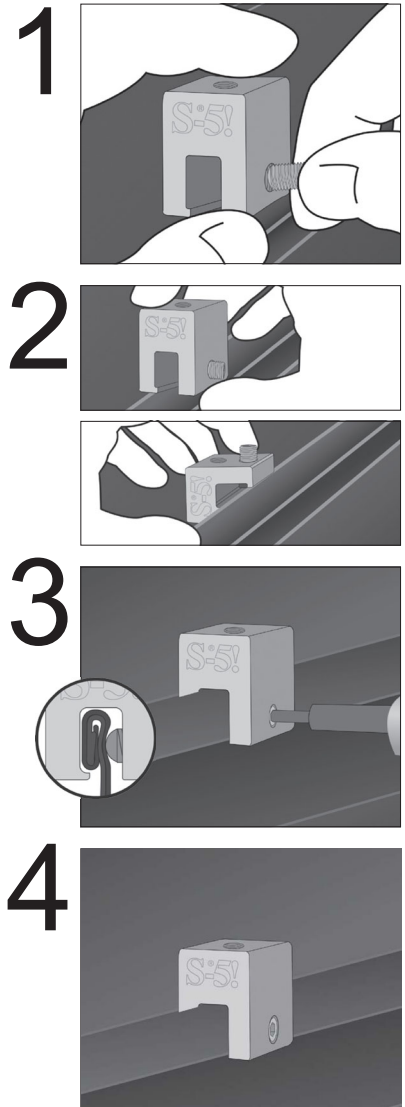

Above illustrations show S-5-E Mini clamp on a vertical seam. Step 2 shows S-5-E Mini on vertical applications and S-5-U Mini on horizontal applications.

## SECTION 07 72 53

### Blizzard Heavy Duty III Clamp to Seam Snow Guards

#### PART 1 - GENERAL

##### 1.1 SUMMARY

- A. Section Includes:
  - 1. Snow guards for metal roofs.
  - 2. Non-penetrating attachment system.

##### 1.2 RELATED SECTIONS

- A. Division 01: Administrative, procedural, and temporary work requirements apply to this section.
- B. Section 07 41 13 - Metal Roof Panels
- C. Section 07 61 00 - Sheet Metal Roofing
- D. Section 07 62 00 – Sheet Metal Flashing and Trim
- E. Section 07 72 55 - Roof Accessory Attachment System
- F. Section 13 34 19 – Metal Building Systems

##### 1.3 REFERENCES

- A. Aluminum Association (AA) ([www.aluminum.org](http://www.aluminum.org)) - Aluminum Standards and Data, 2003 Edition.
- B. ASTM International (ASTM) ([www.astm.org](http://www.astm.org)):
  - 1. A484/A484M-16 – Standard Specifications for General Requirements for Stainless Steel Bars, Billets, and Forgings
  - 2. A554-16 – Standard Specification for Welded Stainless Steel Mechanical Tubing
  - 3. A555/A555M-16 – Standard Specification for General Requirements for Stainless Steel Wire and Wire Rods
  - 4. B85-03 - Standard Specification for Aluminum-Alloy Die Castings
  - 5. B221-04a - Standard Specification for Aluminum and Aluminum-Alloy Extruded Bars, Rods, Wire, Profiles, and Tubes
  - 6. F836M-02 (2015) – Standard Specification for Style 1 Stainless Steel Metric Nuts (Metric).
  - 7. F880-12 – Standard Specification for Stainless Steel Socket, Square Head, and Slotted Headless-Set Screws

##### 1.4 SUBMITTALS

- A. Action Submittal:
  - 1. Shop Drawings: Include roof plans showing locations of snow guards on roof and attachment details and spacing, signed and sealed by a professional engineer.



2. Product Data:
    - a. Product description.
    - b. Construction details.
    - c. Material descriptions.
    - d. Individual component dimensions.
    - e. Finishes.
    - f. Installation instructions.
  3. Samples:
    - a. Clamp samples.
    - b. 12-inch (305 mm) long cross member samples including all associated hardware.
- B. Informational Submittals:
1. Include calculation of number and location of snow guards based on designed roof snow load, roof slope, roof type, components, spacings and finish.
  2. Test results: Results of product tensile load testing, issued by a recognized independent testing laboratory, showing ultimate load-to-failure value of attachment.
- C. Closeout Submittals:
1. Certification: Installer's certification that snow guard system was installed in accordance with manufacturer's instructions and approved Shop Drawings.

## 1.5 QUALITY ASSURANCE

- A. Manufacturer Qualifications: Manufacturer to specialize in production of Snow Guard Products of the type specified with a minimum of 20 years documented experience.
- B. Installer Qualifications: Installer to specialize in metal roof installation and installation of Snow Guard Products with a minimum of 5 years documented experience.
- C. Mockup:
1. Size: Minimum [8] [ ] feet [mm] long.
  2. Show: Snow guard attachment, cross members, and accessories.
  3. Locate [where directed.] [\_\_\_\_.]
  4. Approved mockup may remain as part of the Work.

## 1.6 DELIVERY, STORAGE AND HANDLING

- A. Deliver components to jobsite properly packaged to provide protection during transport, delivery and handling.
- B. Store products in manufacturer's original labeled and unopened packaging in a clean and dry location, protected from potential damage, until ready for application.

## PART 2 - PRODUCTS

### 2.1 SYSTEM DESCRIPTION

- A. Attachment system to provide attachment to standing seam metal roofs:
1. With only minor dimpling of panel seams.
  2. Without penetrations through roof seams or panels.
  3. Without use of sealers or adhesives.
  4. Without voiding roof warranty.

- B. Performance Requirements: Provide snow guards to withstand exposure to the weather and environmental elements, and resist design forces without failure due to defective manufacture.
1. Loading: Design snow guard system to resist minimum in-service vector load of [ ] pounds per linear foot of eave.
  2. Factor of safety: Utilize a factor of safety  $\geq$  [2] [ ] to determine allowable loads from ultimate tested clamp tensile load values.
  3. Source Limitation: Provide snow guard system as designed and tested by the manufacturer as a complete system. Install components by the same manufacturer.

## 2.2 MANUFACTURER

Acceptable Manufacturer: Rocky Mountain Snow Guards, Inc., 4231 S. Natches Ct., Unit C, Englewood, CO 80110; Tel: 720-379-7756; Fax: 720-387-8361; Email: [info@rockymountainsnowguards.com](mailto:info@rockymountainsnowguards.com). Web: [www.rockymountainsnowguards.com](http://www.rockymountainsnowguards.com).

## 2.3 FENCE-TYPE SNOW RETENTION SYSTEMS FOR STANDING SEAM METAL ROOFS

- A. Basis of Design: Blizzard Heavy Duty III, manufactured by Rocky Mountain Snow Guards, Inc.
- B. Components:
1. Clamps
    - a. Manufactured from 6061-T6 aluminum extrusions conforming to ASTM B221 or aluminum castings conforming to ASTM B85 and to AA Aluminum Standards and Data.
      - 1) Model: No. [S-5-U [S-5-S [S-5-T ] [S-5-Z ] [S-5-Q ] [S-5-H [S-5-H90 ] [S-5-V Mini.]
    - b. Set screws: 300 Series stainless steel, 18-8 alloy, 3/8 inch (9.525 mm) diameter, with round nose point.
    - c. Attachment bolts: 300 Series stainless steel, 18-8 alloy, 8 mm diameter, hex flange bolt.
  2. Brackets:
    - a. Manufactured from 5000 Series alloy and temper aluminum conforming to ASTM B221 and AA Aluminum Standards and Data.
  3. Aluminum Tubing (Cross Members):
    - a. Manufactured 6005a-T61 Series alloy and temper aluminum extrusions conforming to ASTM B221 and AA Aluminum Standards and Data.
      - 1) 1" O/D Tubing with .125" thickness walls.
  4. End Collar:
    - a. Manufactured from 6005a-T61 Series alloy and temper aluminum extrusions conforming to ASTM b221 and AA Aluminum Standards and data, with 1/4-20 x 3/8 inch (9.525 mm) stainless steel set screw.
      - 1) End Collar
  5. Ice Flags:
    - a. Aluminum.
      - 1) 3.5" wide.
  6. End Caps:
    - a. Stainless Steel.

## **PART 3- EXECUTION**

### **3.1 EXAMINATION**

- A. Prior to beginning installation, verify that:
  - 1. Panel seaming is complete.
  - 2. Panel attachment is sufficient to withstand loads applied by snow guard system.
  - 3. Installation will not impede roof drainage.

### **3.2 PREPARATION**

- A. Clean areas to receive attachments; remove loose and foreign matter that could interfere with installation or performance.

### **3.3 INSTALLATION**

- A. Install system in accordance with manufacturer's instructions and approved Shop Drawings.
- B. Blizzard Heavy Duty III Snow Retention System:
  - 1. Pre-load 1 set screws into each clamp.
  - 2. Align clamp placement using a string line or laser guide light. 1<sup>st</sup> row is usually placed 12" from eave edge. Additional rows may be necessary. Placement of those rows must follow Rocky Mountain Snow Guards Snow Retention Plan for each project.
  - 3. Clamps may be a maximum of 48" apart.
  - 4. Reference installation instructions for the specific clamp used to assure they are oriented correctly. Torque ratings and specific clamp installation instructions are available at [www.s-5.com](http://www.s-5.com).
  - 5. Tighten clamp set screws to manufacturers recommended torque. Test set screw torque using calibrated torque wrench.
  - 6. Insert Tubing through brackets. Insert swaged tubing end into non-finished end of the adjacent tube.
  - 7. Slide End Collars over tubes making sure that the Collars are on the INSIDE of the last Blizzard Heavy Duty III bracket on each run. This is necessary to hold the swaged tubing ends together within a run.
  - 8. Cut extended end of tube at end of run. Do not cantilever tubes more than 4 inches (101.6 mm) beyond last bracket at ends.
  - 9. Apply end cap to each tube.
  - 10. Install one Ice Flag per panel for panels less than 18" wide. Install 2 Ice Flags for panels wider than 18".
    - a. Secure each Ice Flag by tightening the upslope nut until the Ice Flag will not slide side to side on the tube.

END OF SECTION



# Rocky Mountain Snow Guards Inc

ROCKY MOUNTAIN SNOW GUARDS  
4231 S. NATCHES COURT, UNIT C  
ENGLEWOOD, CO 80110  
PHONE: (877) 414-7606  
FAX: (720) 387-8361  
[www.rockymountainsnowguards.com](http://www.rockymountainsnowguards.com)

## Rocky Mountain Snow Guards Snow Retention System Maintenance Guide

Systems designed by Rocky Mountain Snow Guards, installed properly should last the life of the roof. Rocky Mountain does not recommend adhesive tape or sealant attachment for any snow fence or snow guard system. Rocky Mountain snow retention systems installed on commercial buildings, above high traffic areas or in areas with high snow loads should be inspected by a qualified roofing or snow retention professional on an annual basis to ensure the system will continue to perform as designed.

### Bolt Down Snow Fence Systems:

1. Inspect brackets, snow fence components and fasteners for evidence of damage.
2. Replace damaged parts prior to the next snow season.

### Clamp to Seam Snow Fence and Snow Bar Systems:

1. Inspect brackets, snow fence and snow bar components for evidence of damage.
2. Replace damaged parts prior to the next snow season.
3. Check torque on set screws with an appropriate torque wrench.
4. Torque set screws to recommended torque. This is especially important after the 1st snow season.

### Snow Guards:

1. Inspect snow guards for evidence of damage.
2. Inspect exposed fasteners.
3. Replace damaged parts prior to the next snow season.